

America's Spaceport

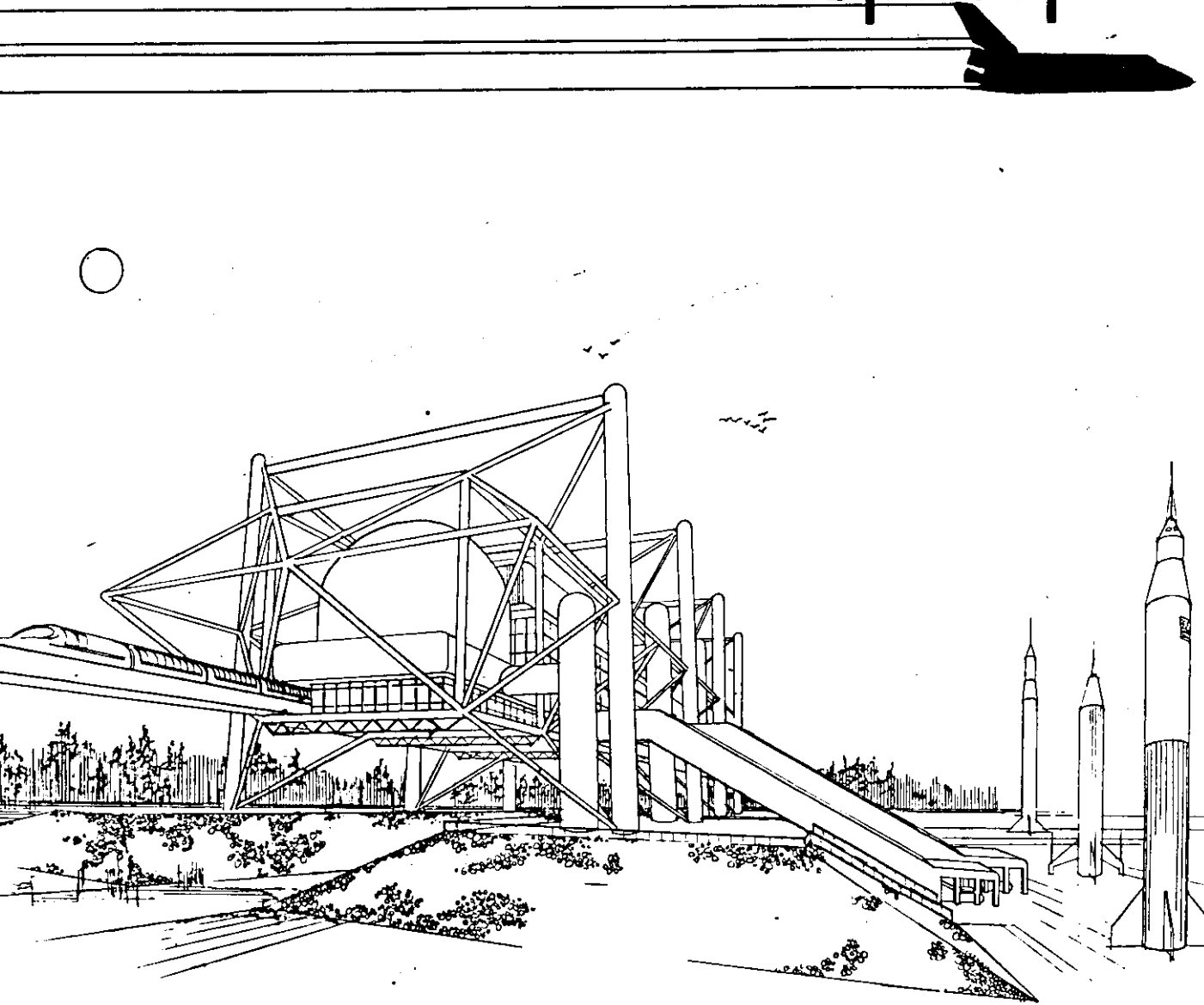

AN ARCHITECTURAL THESIS PROPOSAL FOR A NEW KENNEDY SPACE CENTER VISITOR'S CENTER
MICHAEL E. BALAY - AUGUST 1983 - COLLEGE OF ARCHITECTURE - BALL STATE UNIVERSITY

<u>CONTENTS</u>	<u>PAGE</u>
INTRODUCTION	1
LOCATION MAP	2
PROPOSAL, CLIENTS AND USERS	3
DESIGN SKETCHES	4
FORMAL OBJECTIVES	5
PROGRAM SUMMARY	6
FUNCTIONAL OBJECTIVES	7
WEST ELEVATION AND SITE PLAN	8
TEXT	9
SECTION	10
TEXT	11
LEVEL ONE PLAN	12
TEXT	13
LEVEL TWO PLAN	14
TEXT	15
LEVEL THREE PLAN	16
TEXT	17
LEVEL FOUR PLAN	18
TEXT	19
LEVEL FIVE PLAN	20
TEXT	21
MAP OF KENNEDY SPACE CENTER	22
BACKGROUND INFORMATION, SITE CONTEXT	23
CONTINUED	24
EDUCATION AND AWARENESS AND THE PRESS	25
SHUTTLE LANDING ILLUSTRATION	26
REASONS FOR CHOOSING THIS PROJECT	27
"ARE YOU 'PRO-SPACE'?"	28
CONCLUSION	29

INTRODUCTION

"An unlikely looking flying machine stands on its tail above the watery, thicketed Florida landscape. The time is the mid 1980's, and the Space Shuttle preparing for launch is one of a fleet that now flies routinely, about one roundtrip a week, between the United States and Earth orbit."

No Future World or EPCOT Center can come close to the spectacular, real events being staged every day at the Kennedy Space Center. There is a wonderful opportunity at America's Spaceport for enhancing relations between the general public and the technocratic, scientific community. In addition to improving NASA's public relations, wide range understanding and acceptance of progressive technologies would result in economic and social benefits for all of us.

As routine as the Space Shuttle will make space travel, the fascination of the American people with their Spaceport is expected to only increase on into the 21st century. Through the end of 1980, over 15 million people had toured the Spaceport. The number of visitors has steadily increased, and now approaches two million every year.

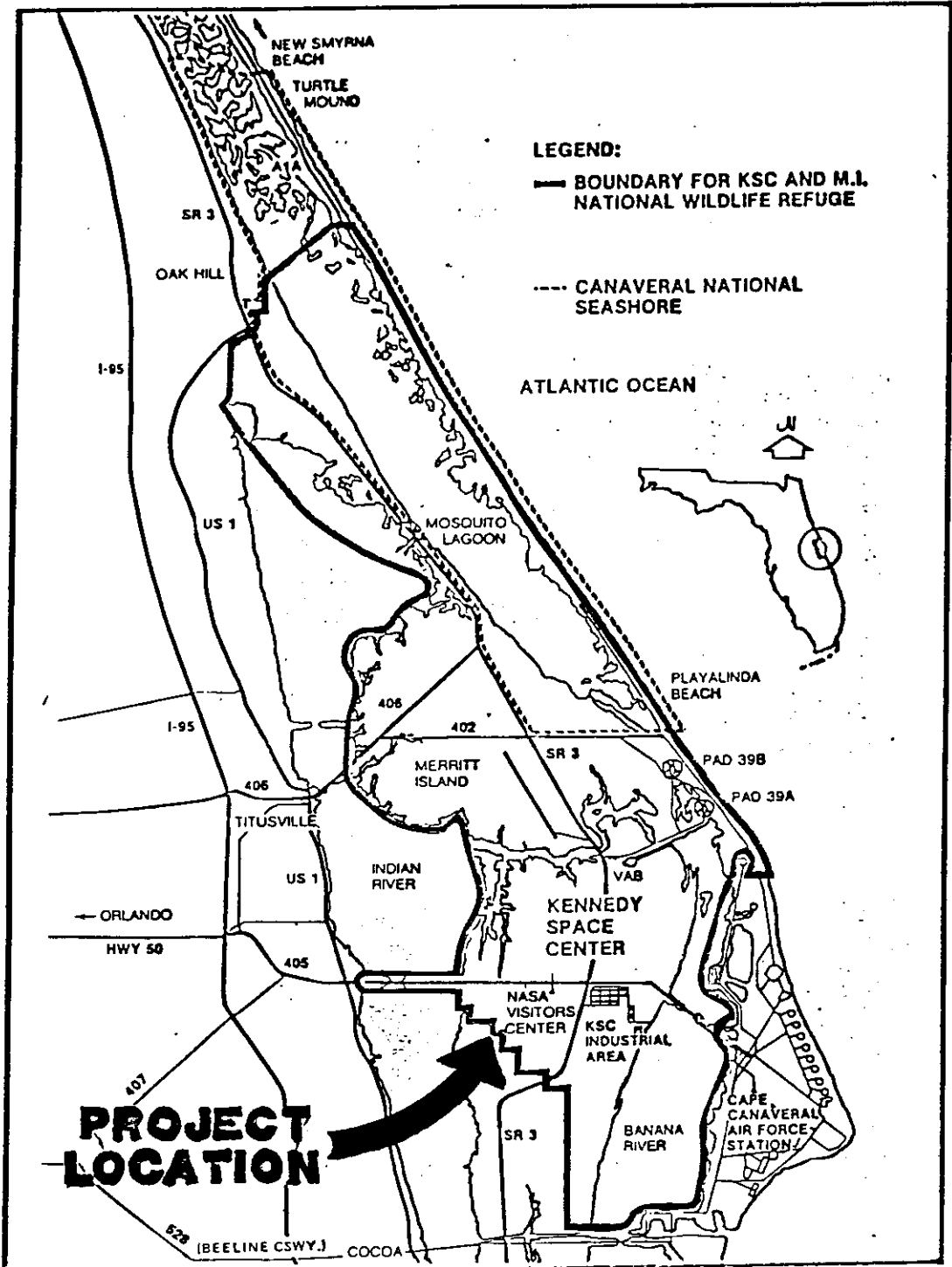

PROPOSAL

This architectural thesis is a proposal for a new Kennedy Space Center Visitor's Facility (including an elevated monorail transit system) to replace the existing Visitor's Center and bus tours. The existing facilities are very inadequate and a new facility to accommodate visitors is badly needed at the Space Center. The new facility can also serve as the core to a Theme Park development in the future.

CLIENTS AND USERS

The client will be the Visitor's Center and Tours Division of the Education and Awareness Branch of the National Aeronautics and Space Administration (NASA), Cape Canaveral, Kennedy Space Center, Florida.

The users will be any visitors to the Kennedy Space Center constituting a wide range of people from all over the world.

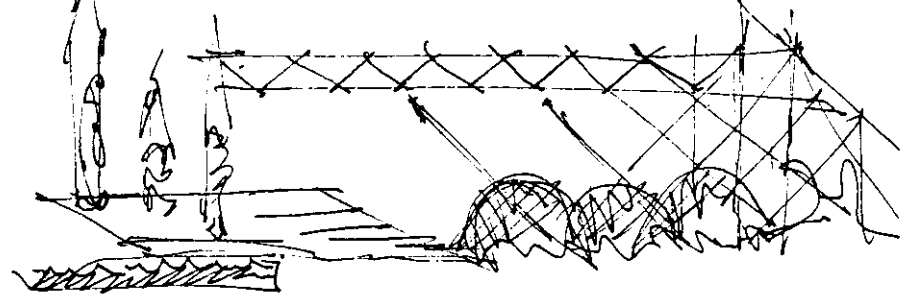
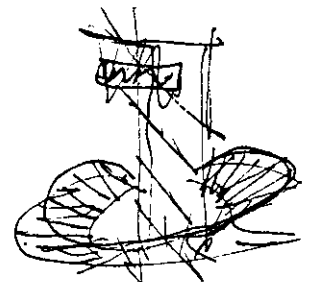
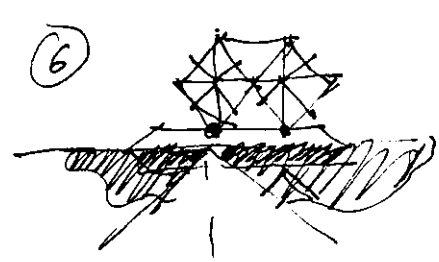
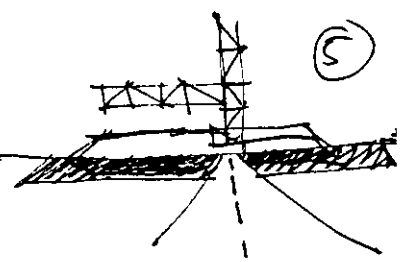
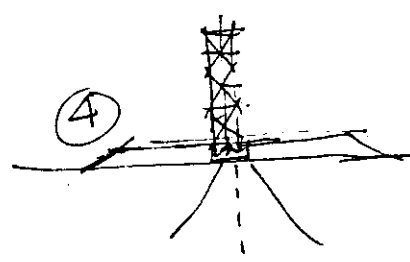
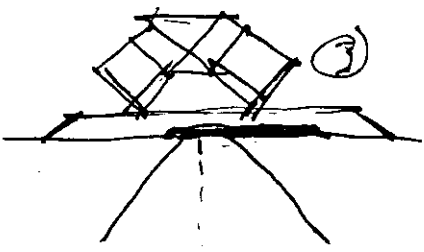
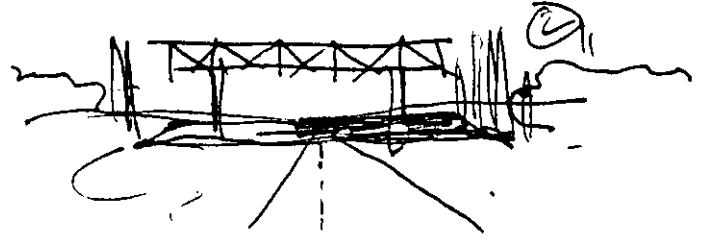
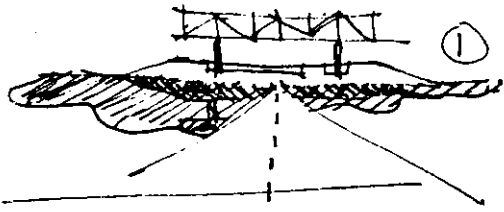

FORMAL OBJECTIVES

The immense steel and concrete structures of the launch base seem like extra-terrestrial constructions; islands of technology abiding harmoniously with the surrounding landscape. The huge scale and high technology of all the facilities overwhelms the visitor, and leaves him awestruck.

America's Spaceport deserves a visitor's facility that does justice to the truly awe-inspiring nature of the place. The Visitor's Center should evoke the same image and character as the other structures at the Space Center.

This overall design goal breaks down into three major formal objectives for the design of the facility:

1) Hi-tech yet Utilitarian Image

This objective reflects the desire for an awe-inspiring structure of a huge scale that seems to exist in the landscape as a colossal, unworldly sculpture. At the same time, though, the design should be utilitarian and functional (not too flashy) in keeping with the nature of the other structures on the launch base.

2) "Gateway" to America's Spaceport

The design should interact with the landscape and the main automobile approach (the NASA Causeway) to create a symbolic image of "Gateway" to the Spaceport. In order for there to be a "Gateway", the design should represent a barrier as well to the visitors thus demonstrating the restricted nature of the launch base.

3) Dichotomy between Service Structure and Encapsulated Spaces

This concept for the design reflects the image of the Space Shuttle on the launch pad: Next to the Shuttle there is the gantry; a structural, guts-oriented service tower which contrasts with the sleek, skin-oriented Space Shuttle which it serves. Likewise, the people spaces in the Visitor's Center can be sleek, encapsulated volumes supported and serviced externally from remote structural and mechanical systems.

PROGRAM SUMMARY

<u>1) EXPLORATORIUM</u>	30,000 sq.ft.
Hands-on exhibits of Space Program spinoff products and technologies.	
<u>2) EXHIBIT CAPSULES</u>	40,000 sq.ft.
Hi-tech exhibits of space hardware, history of space flight, current and future space pursuits.	
<u>3) 2 SENSONIC SPHERE THEATRES</u>	20,000 sq.ft.
Computer designed 360° domed theatres for exhibition of NASA films, laser light shows, planetarium projections, and animated spaceflight simulations.	
<u>4) EDUCATION ZONE</u>	16,000 sq.ft.
9,000 sq.ft. Educator's Resource Library, 3,000 sq.ft. offices, 4,000 sq.ft. lecture rooms.	
<u>5) TRANSIT CONNECTION</u>	12,000 sq.ft.
Loading Platform for monorail tours- 200' x 50' plus 2,000 sq.ft. ticket sales areas.	
<u>6) OBSERVATION PLATFORMS</u>	3,000 sq.ft.
1,000 lin.ft. of observation to the east on eastern edge of circulation tubes plus additional outdoor platforms.	
<u>7) 2 CAFETERIAS</u>	12,000 sq.ft.
2,500 sq.ft. eating, 1,500 sq.ft. kitchen, 1,500 sq.ft. storage.	
<u>8) SHOPPING</u>	4,000 sq.ft.
Gifts, souvenirs, slides, books, clothing, snacks...	
	137,000 sq.ft.
	+ 25% circulation =
	<hr/> 170,000 sq.ft. TOTAL <hr/>

FUNCTIONAL OBJECTIVES

This Visitor's Center functions as many things. As mentioned, it functions as a symbolic "Gateway" to America's Space Center. Past its gates, Mankind literally knows no boundaries. His machines, launched from this Spaceport, are right now leaving our Solar System and entering interstellar space.

Besides "Gateway", the Visitor's Center functions as a "Physical Connector", via the monorail tours, to the Space Center, getting people close enough to almost touch the spaceships and structures on the base. In addition, it functions as a "Visual Connector" or "Window" on the Space Center, allowing a panoramic view of the launch base. The Center also functions as "Home" for the visitor's while they spend the day there and should provide shelter, eating, resting, and shopping areas.

The more specific functions needed at the Visitor's Center are "Exhibition", "Hands-on demonstration", "Education", and "Theatre". These are the traditional "museum-like" functions present already in the existing Visitor's Center, but the similarities end there.

It's important that the new facility be designed to accomodate state-of-the-art exhibitions and theatre productions. In addition, space should be provided for exhibition of real space hardware showing the history of Man's exploration of space as well as models and simulations of future pursuits. As many exhibits as possible should be participatory in nature. Literally hundreds of TV touchscreens and Video Display Terminals will be utilized to get the visitor involved as much as possible in exhibits. The visitor will learn about and even get to demonstrate himself the myriad spinoffs and benefits of aerospace pursuits; new technologies, industries, and consumer products.

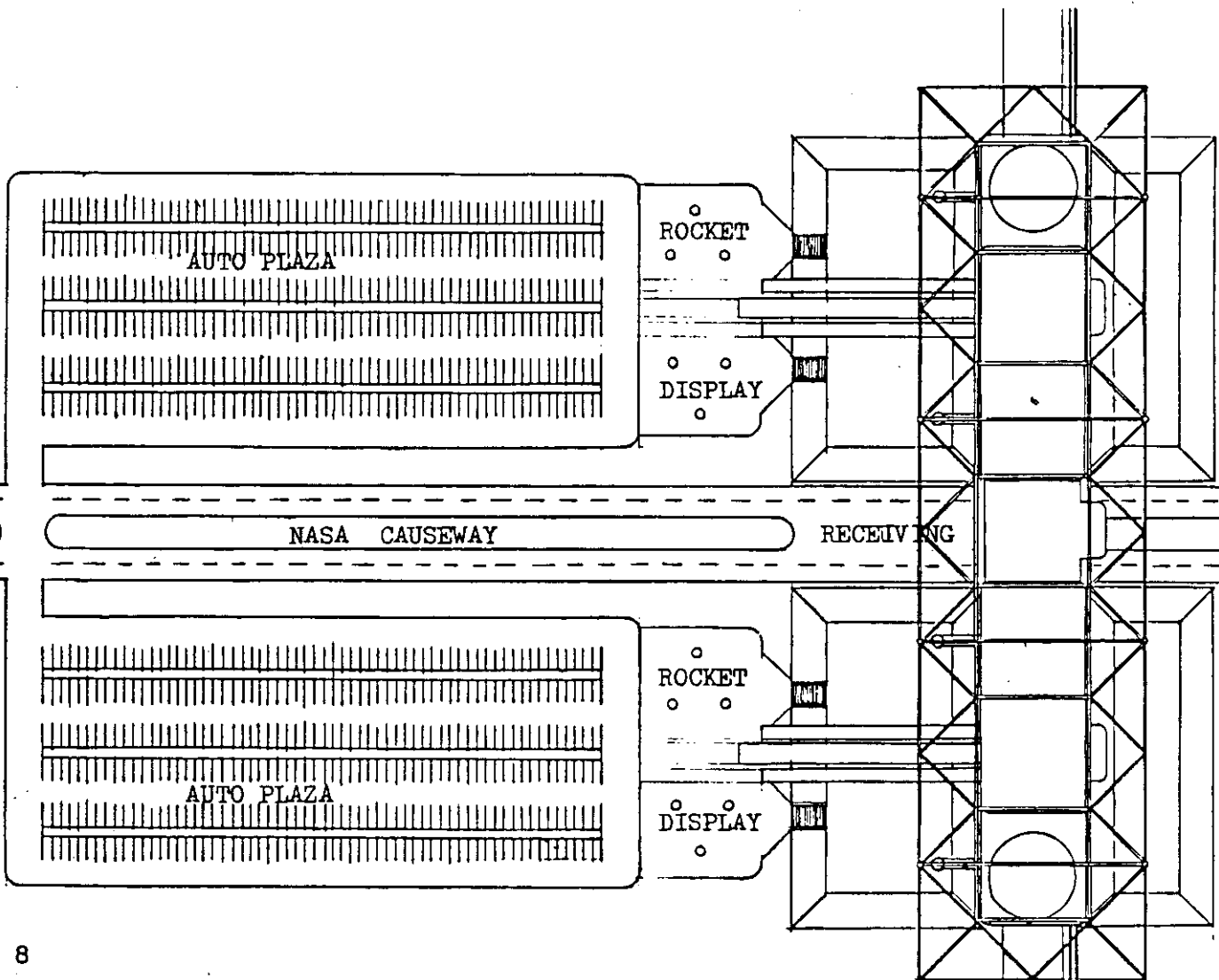
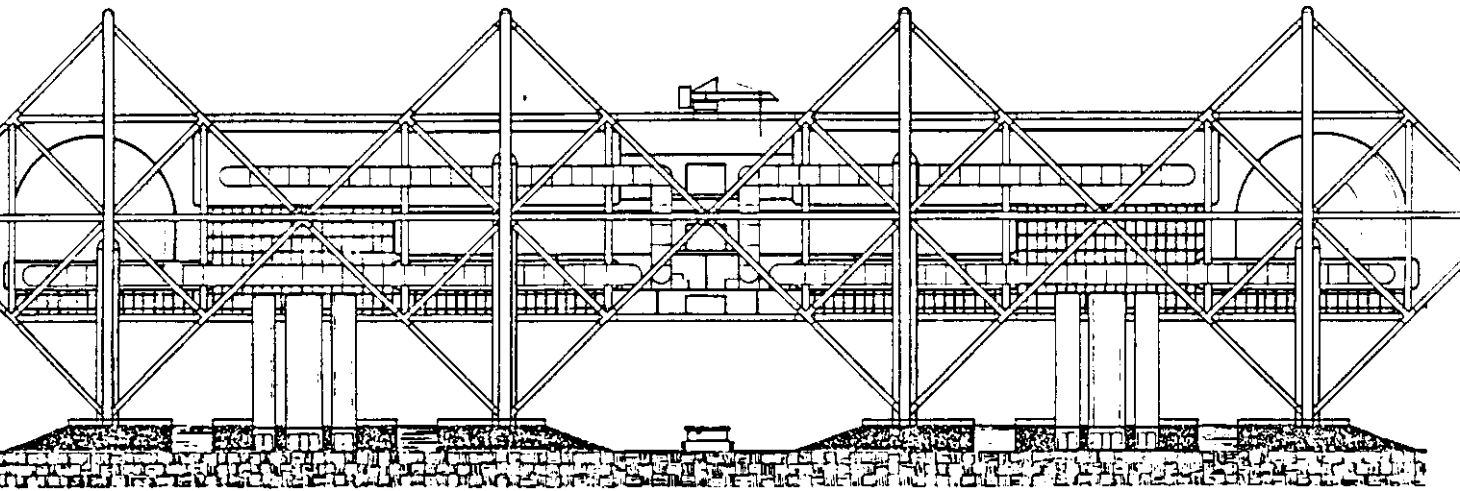

From five miles away, the 20 story high support towers loom on the horizon as we approach the Spaceport via the NASA Causeway.

We tune our AM radios to the posted frequency which directs us to the parking plazas north and south of the causeway, as well as give us background information on the Space Center. The excitement builds as we get closer to the launch site of the Shuttles and the missions to the Moon and planets.

Out of our cars, we continue to head east towards Spaceport Central, its structure towering above us, filling our field of vision. We enter up the escalators which deliver us to witness Mankind's amazing exploits in Space. From the Entry Pad we can see a panorama of the Space Center and board the elevated monorail which takes us on a three hour close-up tour of our Spaceport.

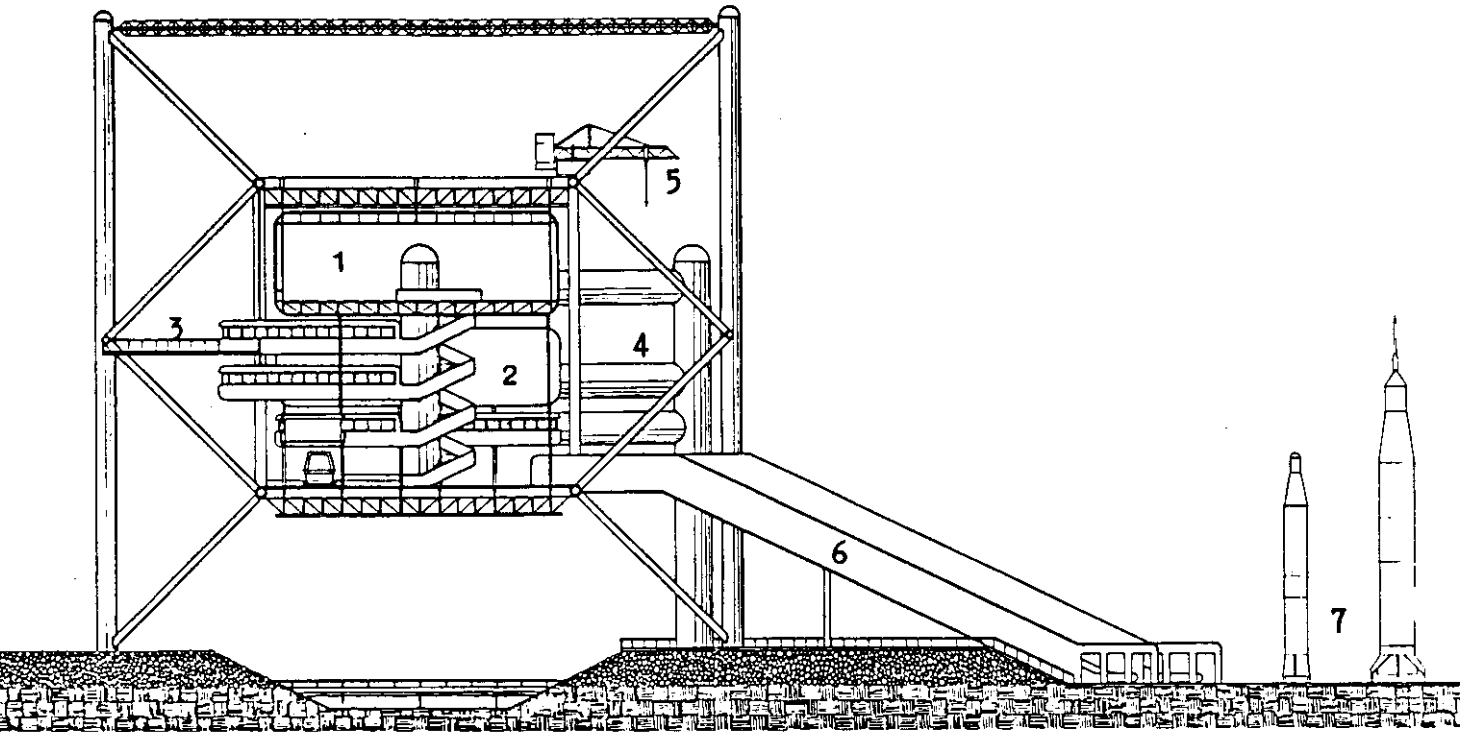

- 1 EXHIBIT CAPSULES
- 2 EXPLORATORIUM
- 3 OBSERVATION PLATFORMS
- 4 EMERGENCY EGRESS TUBES
- 5 RECEIVING CRANE
- 6 ENTRY AND EXIT ESCALATORS
- 7 ROCKET DISPLAYS

The monorail transit station, Sensonic Sphere Theatres, cafeterias, shops, library, lecture halls all occupy lower levels, with Exploratorium and Exhibit Capsules suspended in the upper reaches of the seven 100 foot cubes hovering in space above the Florida landscape.

To the east, suspended above the monorail are the Observatories, Outdoor Observation Platforms, and circulation tubes, and to the west are the emergency egress tubes and towers.

LEVEL ONE

- 1 ENTRY PAD
- 2 ORBIT CAFETERIA
- 3 GIFT SHOPS
- 4 MONORAIL TICKET SALES
- 5 MONORAIL GUIDEWAY
- 6 MONORAIL LOADING/UNLOADING
- 7 RECEIVING/MECHANICAL ROOM
- 8 RESTROOMS

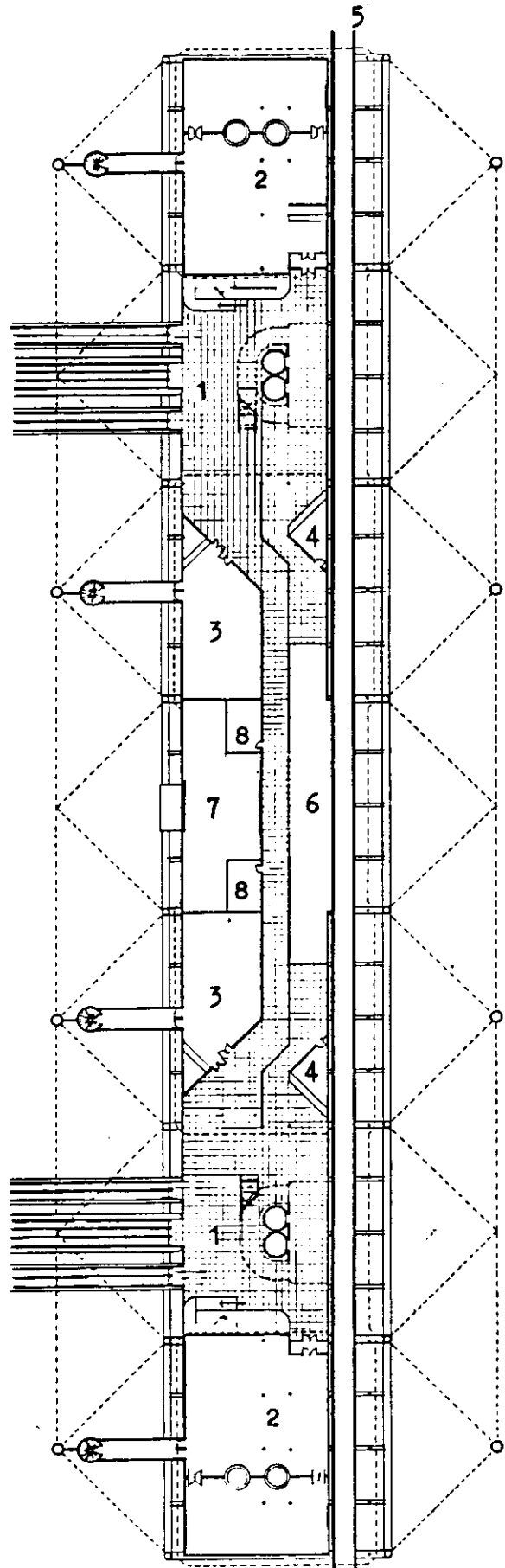

The lowest level serves mainly as Entry Plazas and Transit Mall. Other utilitarian visitor needs are met on the first level such as eating in the Orbit Cafeterias, resting on the Entry Pads, and souvenir shopping on the Mall.

Visitors move up to the rest of the facility via the main stairways in the middle of the Entry Pads or by the four elevators. Access to the Sensonic Sphere Theatres is also from the Entry Pads up the long switchback ramps.

LEVEL TWO

- 1 ENTRY PAD
- 2 SENSONIC SPHERE THEATRES
- 3 EDUCATOR'S RESOURCE LIBRARY
- 4 LECTURE ROOMS/OFFICES

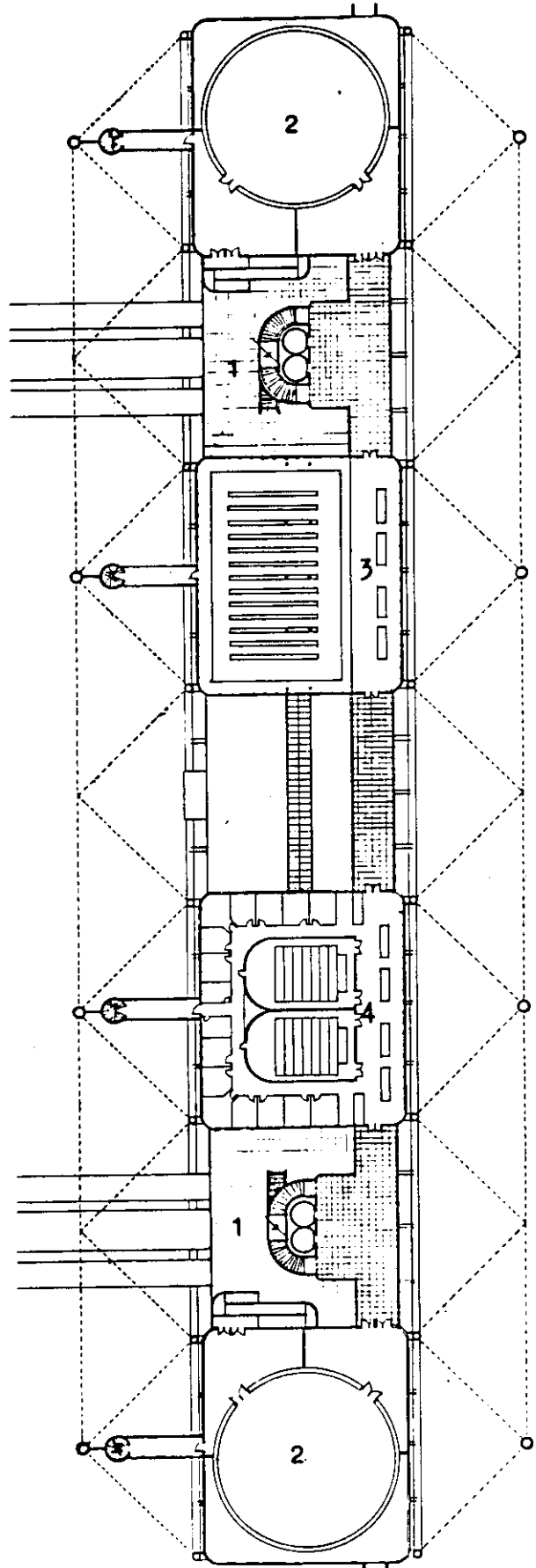

The major feature of level two is the Sensonic Sphere Theatres. Each one holds 300 people for about a half hour fantastic journey through the Cosmos. The theatre domes pulsate with laser lights, hundreds of strobes, star fields, NASA films, all simulating space flight, or any other Cosmic experiences the producer desires.

The Education Zone occupys the rest of level two consisting of the Educator's Resource Library, a source of NASA information for students and teachers, and lecture rooms and administrative office space. Seminars and conferences will also take place in this Zone.

LEVEL THREE

- 1 OBSERVATORY
- 2 EXPLORATORIUM
- 3 RECEIVING

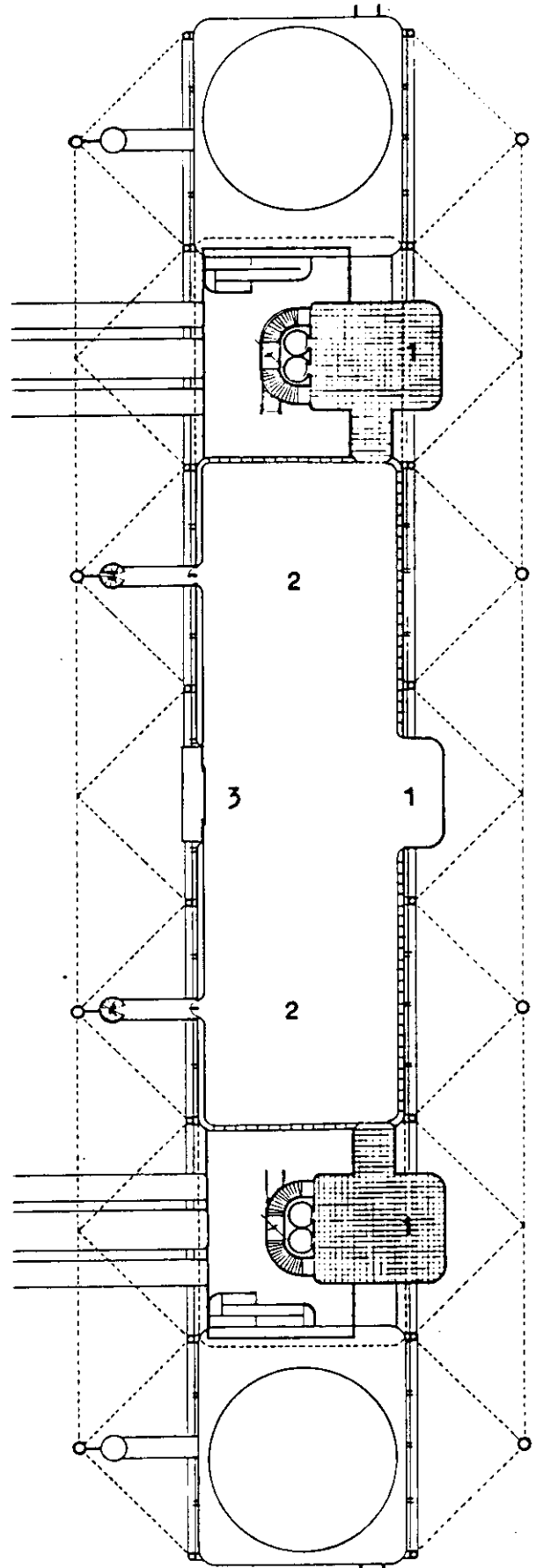

Occupying the third level is the Exploratorium, a large open space where participatory exhibits constantly change; where there are no rules and kids are allowed to touch and climb on anything they like.

These hands-on exhibits will serve to teach the visitors about spinoff products of space programs by allowing them to demonstrate them themselves. Visitors should leave the Space Center with a new awareness of how Mankind has benefitted from aerospace pursuits.

LEVEL FOUR

- 1 OBSERVATORY
- 2 OUTDOOR OBSERVATION PLATFORMS

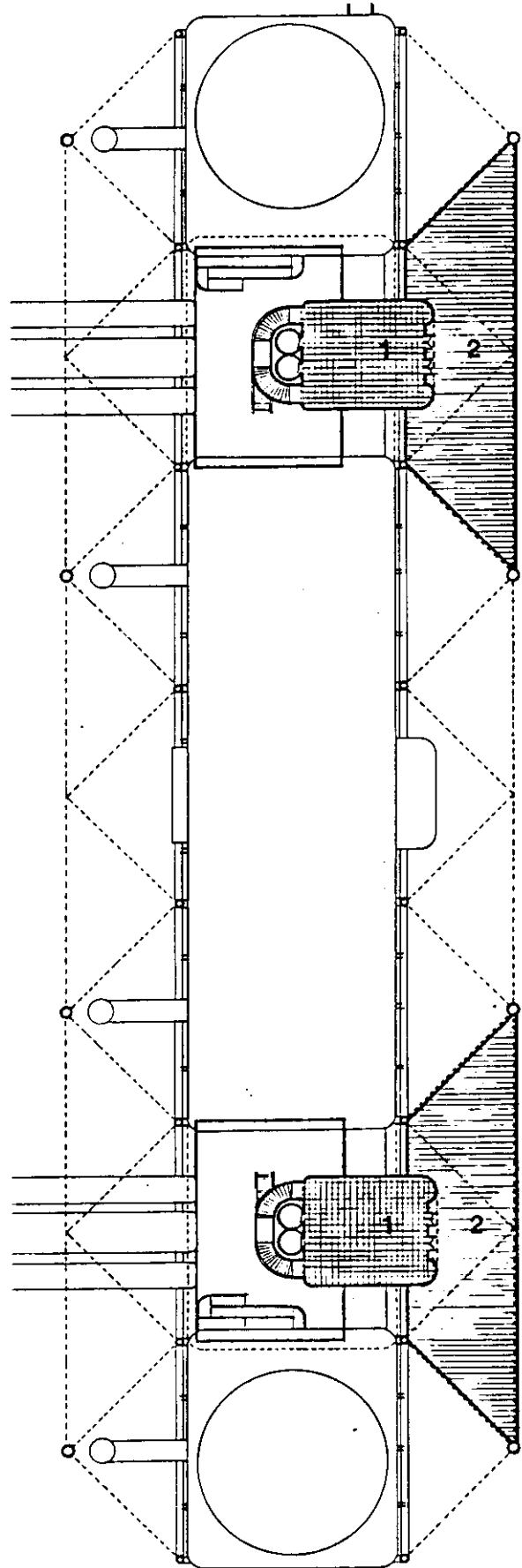

The fourth level is the Observatory level. Here is located indoor observatories and access to outdoor platforms over 100 feet high that provide a fantastic panoramic view of the Kennedy Space Center.

LEVEL FIVE

- 1 OBSERVATORY
- 2 EXHIBIT CAPSULES
- 3 RECEIVING/MECHANICAL ROOM
- 4 RESTROOMS

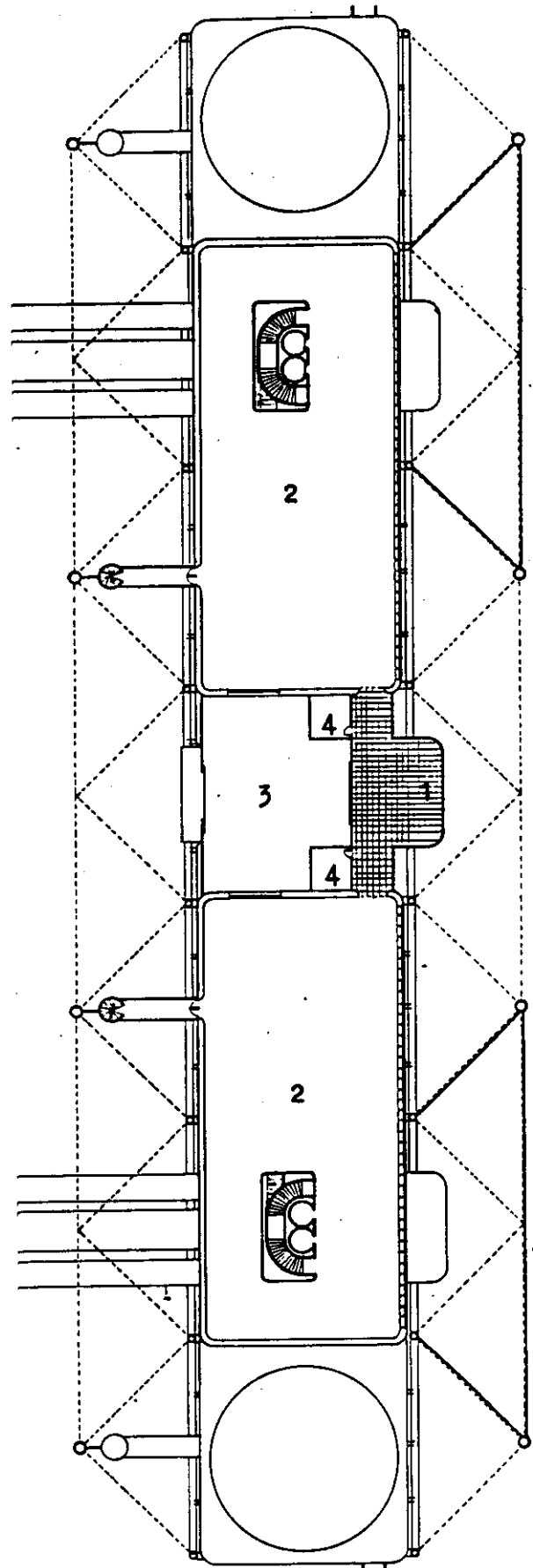

Forming the lofty core of Spaceport Central are the Exhibit Capsules, housing a colorful collage of today's reality and tomorrow's dreams.

Guests explore real space hardware, full scale mock-ups of spaceships and space habitats, and learn about planetary missions, the Space Shuttle Transportation System, space manufacturing, solar energy satellites, and communication networks.

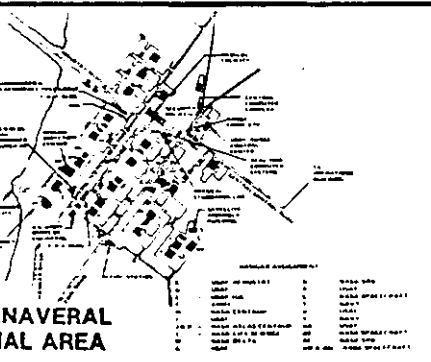
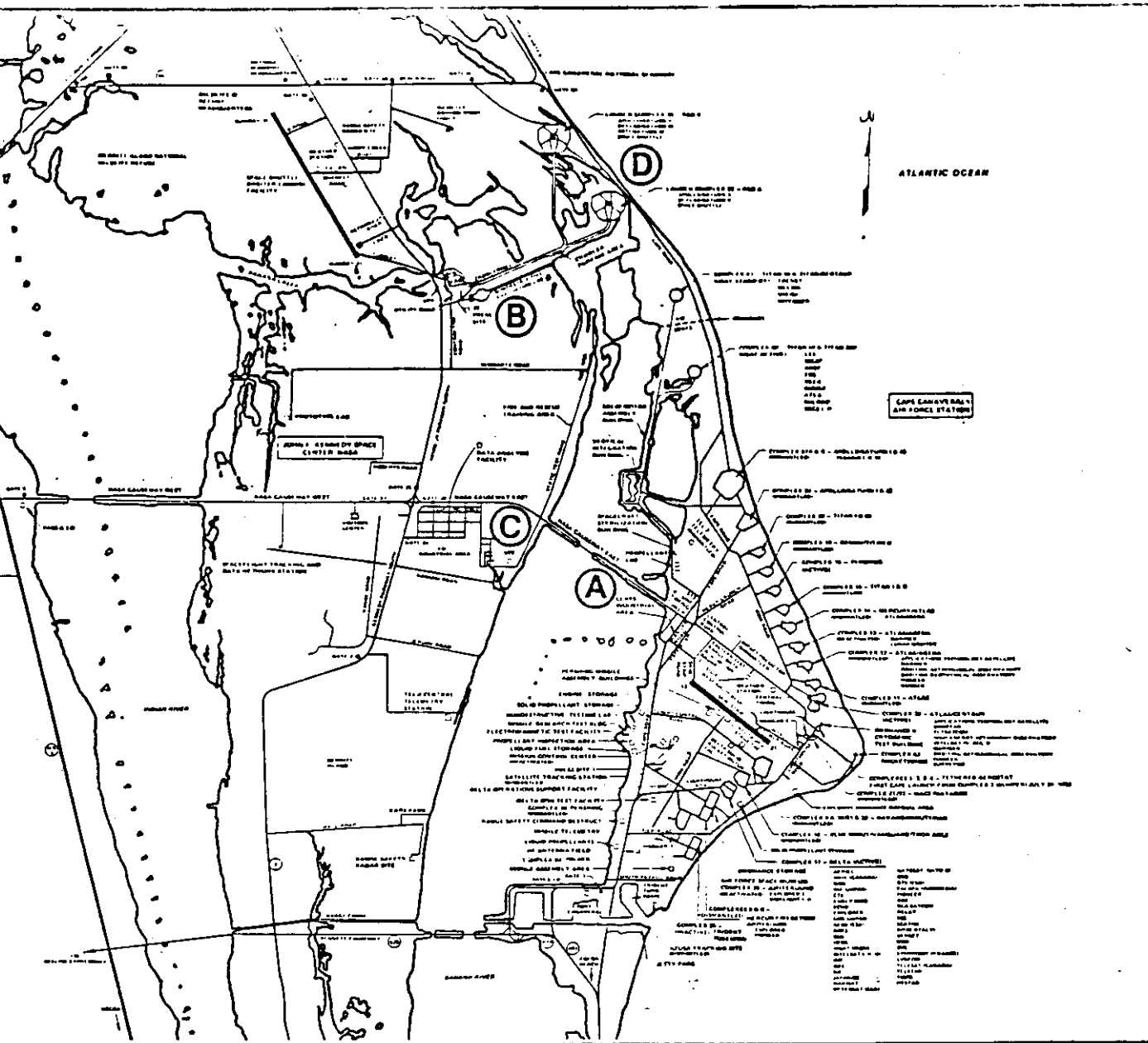

NAVERAL AREA

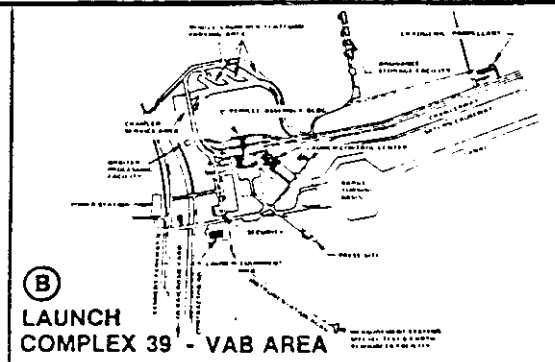

(B) LAUNCH COMPLEX 39 - VAB AREA

FACILITIES AT JOHN F. KENNEDY SPACE CENTER, NASA AND CAPE CANAVERAL AIR FORCE STATION

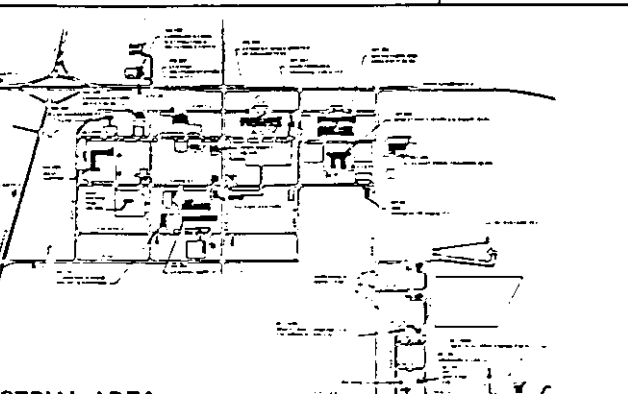

GENERAL AREA

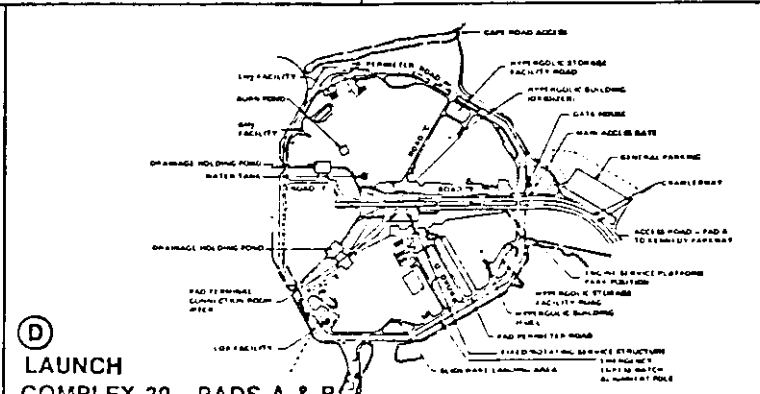

(D) LAUNCH COMPLEX 20 - RADS A & B

BACKGROUND INFORMATION

The following is reprinted from The Kennedy Space Center Story, NASA Publications, Superintendent of Documents, U.S. Government Printing Office, Washington DC:

SITE CONTEXT

Located on the east coast of Florida approximately midway between Jacksonville and Miami, the 56,700 hectares (140,000 acres) controlled by the Center represent a melding of technology and nature. Wildlife thrives here, alongside the structures of the nations major launch base. KSC is a national wildlife refuge, and part of its coastal area is a national seashore by agreement between the National Aeronautics and Space Administration and the Department of the Interior. Over 200 species of birds live here yearround, and in the colder months large flocks of migratory waterfowl arrive from the North and stay for the Winter. Many species of endangered wildlife are native to this area: the Southern bald eagle, dusky seaside sparrow, brown pelican, manatee, peregrine falcon, green sea turtle, and Kemp's Ridley sea turtle.

KSC extends about 55 kilometers (34 miles) from north to south and measures 16 kilometers (10 miles) at its widest point. Located primarily on Merritt Island, the facility is bounded on the east by the Atlantic Ocean and the Banana River, and on the west by the Indian River.

Essentially flat, KSC land averages about 1.5 meters (five feet) above sea level. Extensive marshes and scrub vegetation, including saw palmetto, blanket most of the terrain. Cabbage palm, slash pine and oak grow on higher ground. Long rows of Australian pine protect citrus groves planted by early settlers on Merritt Island.

The nerve center of KSC is Launch Complex 39. This is the location of the Vehicle Assembly Building, where Saturn V vehicles were once prepared for launch. This massive building is now the NASA assembly site for the Space Shuttle.

Some 5.6 kilometers (3.5 miles) to the east of the assembly building are the two launch pads where journeys into space begin. Eight kilometers (five miles) south is the KSC Industrial Area, where many of the Center's support facilities are located. It was here that Apollo crews and spacecraft were readied for their missions. Here also is the administrative headquarters for KSC operations, the offices of the center director and other NASA and contractor managers.

EDUCATION AND AWARENESS

Educational activities play a major role in NASA's program of disseminating information to the public. The Kennedy Space Center's education staff serves a region embracing Florida, Georgia, Puerto Rico, and the Virgin Islands, providing educational resources to professional educators, students of all grade levels, civic groups and various organizations such as PTAs and Scouts.

The educational community is kept up-to-date on NASA research and development programs through conferences, technical briefings, educational television and teacher programs that vary from one-day seminars to two-week participation workshops. "Teacher Kits" containing a wide assortment of comprehensive literature, are mailed to instructors on request.

Aerospace lectures and demonstrations are provided at the Visitor's Center to nearly 50,000 students each year. Educational support is provided to planetariums, science centers, science fairs and youth programs. Annually, the education staff receives and answers about 40,000 letters (15% foreign), distributes approximately 1.5 million publications and loans over 8,000 films.

PRESS

The Press is accommodated at Complex 39 in the vicinity of the VAB. A sheltered grandstand accommodates 350 reporters, with another 2500 in the open field. The press site is about $3\frac{1}{2}$ miles from Pads A and B, location of shuttle launches. Pre-launch briefings are arranged, at which project managers explain the preparations for each launch and talk about the payloads to be carried aloft. After the mission, press representatives are briefed on the results of the operation.

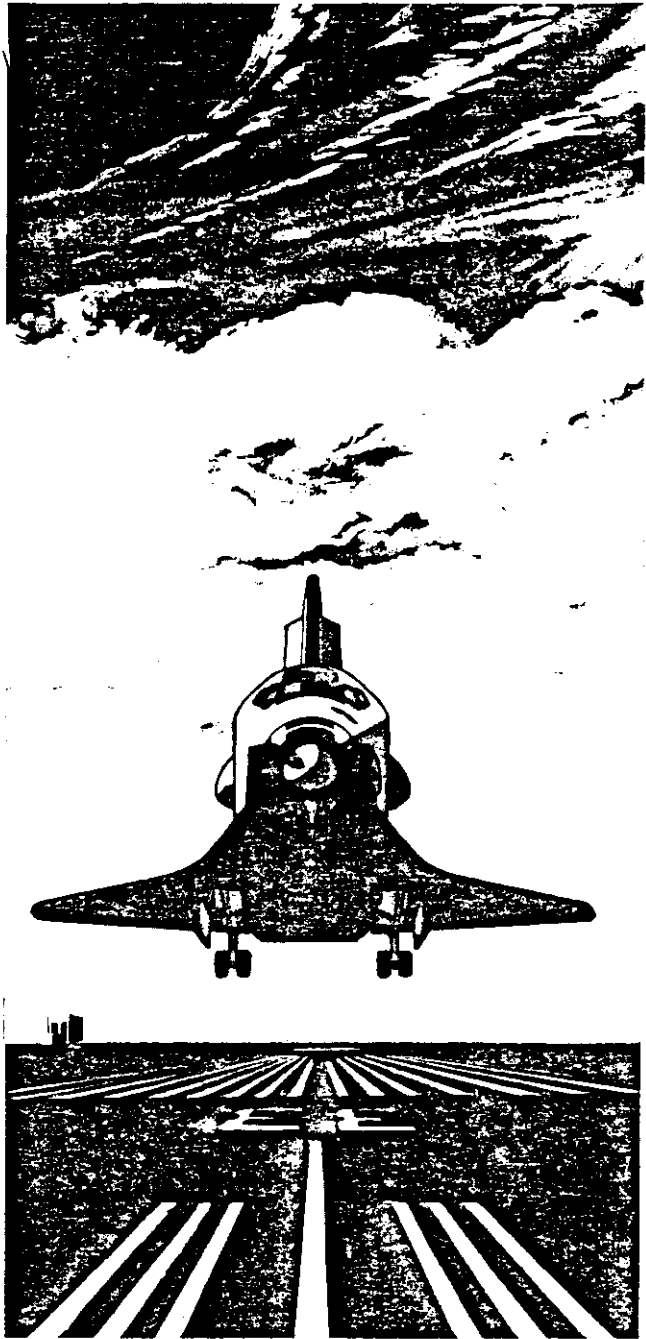

REASONS FOR CHOOSING THIS PROJECT

All of my life I have been interested in Man's exploration of space and have chosen this subject area because I care about it so much.

The way I see it, the central conflict in the world today is not between rich nations and poor nations, or government and business, or technocrats and humanists, but is between the past and the future. We live in a rapidly changing world where new technologies are being born every day and old technologies are dying out, causing temporary disruptions in society. Although this transition period is painful, we live at an exciting time in history when the prospects for Mankind's future have never been more promising.

"A new civilization is emerging in our lives, and blind men everywhere are trying to suppress it. This new civilization brings with it new family styles; changed ways of working, loving, and living; a new economy; new political conflicts; and beyond all this an altered consciousness as well. Pieces of this new civilization exist today. Millions are already attuning their lives to the rhythms of tomorrow. Others, terrified of the future, are engaged in a desperate, futile flight into the past and are trying to restore the dying world that gave them birth.

The dawn of this new civilization is the single most explosive fact of our lifetimes." Alvin Toffler, The Third Wave

Space utilization and space program spinoff technologies are at the forefront of this emerging techno-society. The "Electronics Explosion", the oncoming "Information Age", "Technocratic Age", the looming "Space Age", are all terms referring to emerging technologies that can all trace their origins back to the "space race" to the Moon in the 1960's.

The following is an article by Leonard David, Director of the National Space Institute, reprinted from "Space World" Nov. 1982, that further exemplifies the motivations behind my project:

ARE YOU "PRO-SPACE"?

I'd like to file a complaint concerning one of the silliest terms to come down the gravity well: "Are you *pro-space*?"

This ill-conceived and destructive usage is about as witless as being queried which astrological sign were you born under. We're all guilty of using the phrase—but just what does the expression really mean?

To me, the term immediately fosters visions of the vocal quagmire of pro-abortion, pro-gun, or pro-ERA debates which have rampaged for years devoid of resolution. These are 20th Century versions of the Hatfields and McCoys.

The pro-space movement (if there is one) wreaks of the spaceism that for every action there is an equal but opposite reaction. Therefore, watch out for the "anti-space" movement. They rank right up there with the anti-abortion, anti-gun, and anti-ERA forces. This anti-space constituency is a crafty but seedy bunch, lurking about every corner and launch pad, ready to pounce on the space program at the first sign of a countdown.

I'm sure you've seen the television coverage of the thousands of protesters who picketed the White House demanding an end to using communications and weather satellites. Perhaps you're shocked and dismayed at the countless telegrams that pour into Congress calling for a shut-down of the space program.

The cynical point I'm attempting to make here is that the "pro-space" idiom exudes to a disinterested observer a perception of a great struggle between opposing forces as to closing down or keeping alive this country's space program. The fact is, general public enthusiasm (and these are the disinterested observers) appears to be growing for a strong U.S. space commitment. Additionally, this sentiment is coupled with the budgetary statistic that NASA is doing reasonably well.

Now in saying all this, I want to point out there is a sub-theme at work here. Just what is THE space program? This term is a misnomer. What this country has are numbers of space programs: planetary exploration, application satellites, space

stations, the Space Shuttle Transportation System, etc. For any individual—private citizen to a President—THE space program represents a Rorschach test; each of us may visualize its numerous elements in varying degrees of shape and substance. Sometimes these perceptions are in total conflict. In other words, what one pro-space organization advocates may not garner support of another pro-space group. Remember Solar Power Satellites? How about a space station go-ahead, but at the expense of planetary programs? Recall when the "High Frontier" meant space colonization not Earth-circling rings of anti-ICBM snipers?

In short, to borrow from a movie screened several years ago: "What we have here is a failure to communicate."

I say it's time to lower the battle flag of "pro-space" and subdue the war-cries against the invisible anti-space program invaders. Our job here at NSI and your responsibility as a member is to develop greater public understanding of the *many* ways space can serve both the Nation and the world.

No one person or organization has the answer to the proper ingredients which make up THE space program. But we must strengthen our ability to communicate to those in society, who make up that disinterested majority, that America is richer today because of its space effort.

The inept "pro-space" label drives a wedge into the public mind, needlessly confusing society as to the even richer tomorrows to come, thanks to the Nation's space activities. ★

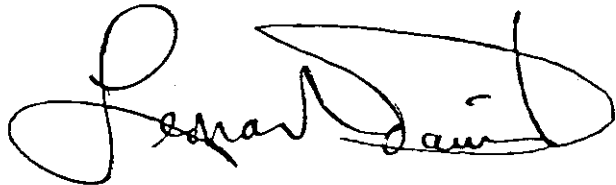

—Leonard David

Leonard David is NSI's Editor and Program Manager, in Washington, D.C.

CONCLUSION

In conclusion I would like to comment on my overriding impressions of the people of NASA from visits and interviews at the Kennedy Space Center.

My biggest impression was of the positive optimism of everyone involved at NASA; optimism about Man and his technology. There are no cynics or long faces down at the Space Center! They have a saying there that illustrates what I mean:

"If it's difficult, we can do it right now; if it's impossible, it may take a little more time."

The second overriding impression of the people at KSC was their real concern for public relations and disseminating information to the public. All over the place visitors see signs "This is your Spaceport", and everyone I talked to stressed the importance of getting the word out about all the spinoff benefits from our many space programs. The motivation behind this is not some greedy propaganda means to get more funding, these people really believe that everything they're working on will greatly benefit all Mankind.

"The agency's Technology Utilization Program provides a link between the technologists, the technology and those who might be able to apply the technology productively. By Congressional mandate, NASA is charged with stimulating the widest possible use of this valuable resource."

Ronald J. Philips
Director, Technology Utilization
and Industry Affairs Division